

 Deutsche
 Qualität
 Garantiert



120

HALF
CELLS

182
mm

CELL
SIZE



LID
RESISTANT



PID
RESISTANT



SALT CORROSION
RESISTANT



SAND
RESISTANT



AMMONIA
RESISTANT



HIGHLY STABLE
AND TOUGH

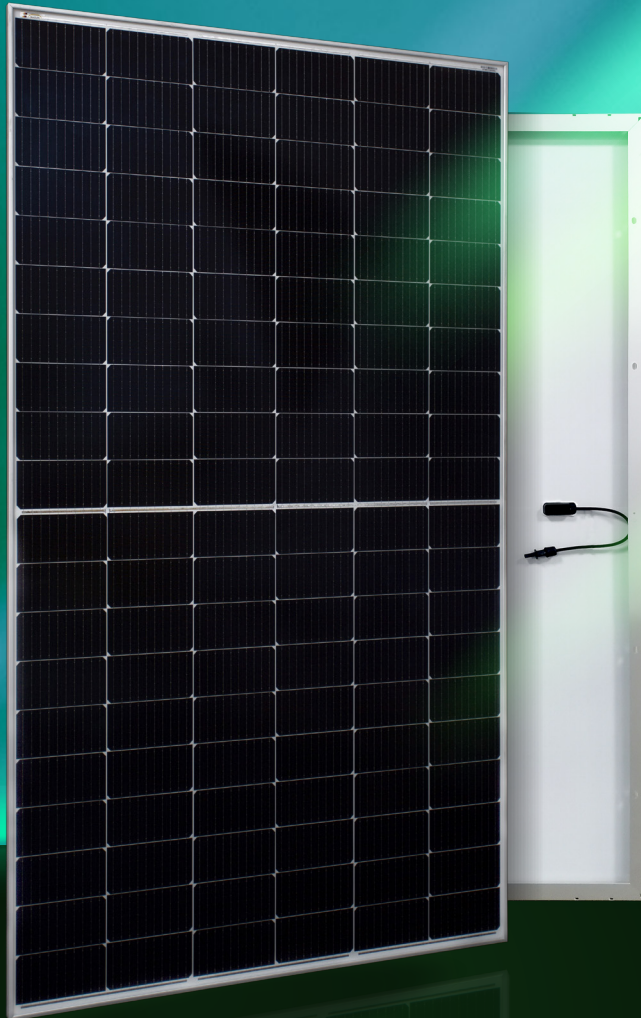

AURORA

HIGH ENERGY YIELD
RELIABILITY
DURABILITY

30

years
Performance
Guarantee

15

years
Product
Warranty

MONO-CRYSTALLINE PV MODULES
HALF-CUT CELLS • MONO-FACIAL

440W-460W

AE MD-120 Series



IEC 61215
IEC 61730
Regular Production Surveillance
Type Tested and Monitored

IEC 62716 (Ammonia corrosion)
IEC 61701 (Salt mist corrosion)
IEC 60068 (Sand and dust)
IEC 62804 (PID resistance)

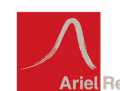

www.ae-solar.com

AE MD-120 Series 440W-460W

Mechanical and design specification

Cell type	Gallium-doped Mono c-Si PERC, Half-cut cells, 182 mm
No. of cells	120
Glass	3.2 mm, high transmission, AR coated, tempered
Encapsulation	EVA
Back cover	White backsheet
Junction box	IP 68 rated
Frame	30 mm anodized Aluminium alloy
Cable	1 x 4 mm ² , 350 mm length or customized
Connectors	MC 4 / MC 4 compatible
Dimension	1902 mm x 1133mm x 30 mm
Weight	23.5 kg
Hail resistance	Max. Ø 25 mm at 23 m/s
Wind load	2400 Pa/ 244 kg/ m ²
Mechanical load	5400 Pa/ 550 kg/ m ²

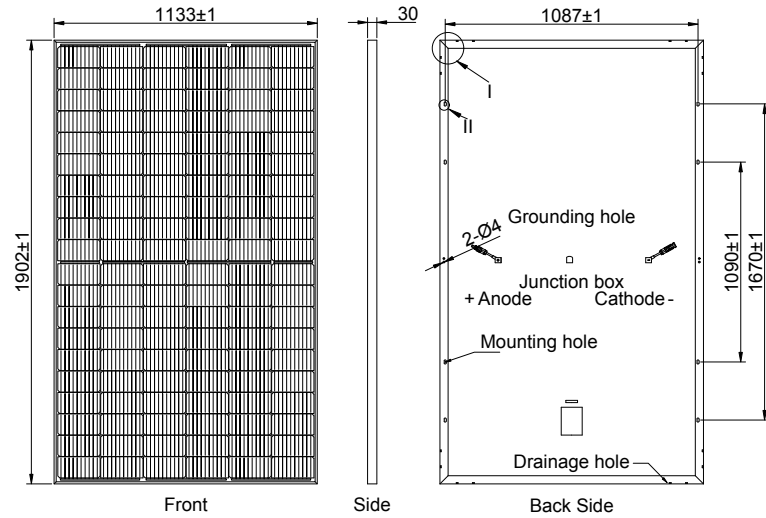

Packaging information

Packaging configuration	72 pcs / double pallets
Loading capacity	864 pcs / 40 HQ
Size / Pallet	1945 mm x 1140 mm x 2490 mm
Weight	1760 kg / double pallets

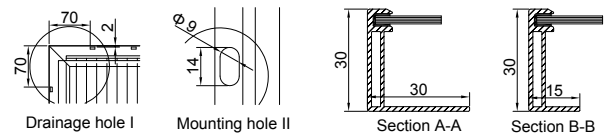

Temperature ratings

Operating temperature (°C)	-40 to +85
Temp. coefficient of P _{max} (%/°C)	-0.35
Temp. coefficient of V _{oc} (%/°C)	-0.275
Temp. coefficient of I _{sc} (%/°C)	0.045
Nom. operating temp. NOCT (°C)	45 ± 2

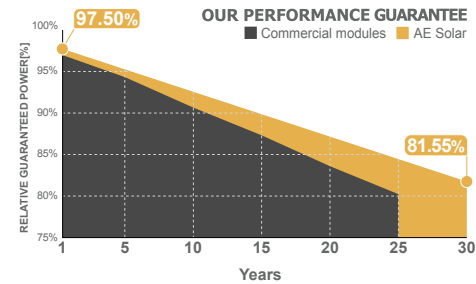
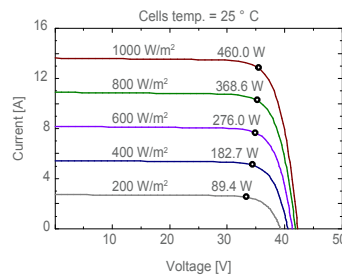

Electrical specifications (STC*):		AE440MD-120	AE445MD-120	AE450MD-120	AE455MD-120	AE460MD-120
Nominal Max. Power	P _{max} (Wp)	440	445	450	455	460
Maximum operating voltage	V _{MPP} (V)	34.62	34.87	35.13	35.38	35.60
Maximum operating current	I _{MPP} (A)	12.71	12.76	12.81	12.86	12.92
Open-circuit voltage	V _{oc} (V)	41.35	41.66	41.98	42.29	42.60
Short-circuit current	I _{sc} (A)	13.47	13.52	13.57	13.62	13.67
Module efficiency	η (%)	20.42	20.65	20.88	21.11	21.35
Power tolerance	(W)	0~+5				
Maximum system Voltage	(V)	1500				
Maximum series fuse rating	(A)	25				

*STC: Standard test conditions (Irradiance 1000 W/m², Cell temperature 25°C and air mass of AM1.5)

Electrical specifications (NMOT*):		AE440MD-120	AE445MD-120	AE450MD-120	AE455MD-120	AE460MD-120
Nominal Max. Power	P _{max} (Wp)	331	335	338	342	345
Maximum operating voltage	V _{MPP} (V)	32.60	32.80	33.00	33.20	33.40
Maximum operating current	I _{MPP} (A)	10.17	10.21	10.25	10.29	10.34
Open-circuit voltage	V _{oc} (V)	38.80	39.00	39.20	39.40	39.60
Short-circuit current	I _{sc} (A)	10.78	10.82	10.86	10.90	10.94

*NMOT: Normal Module Operating Temperature (Irradiance 800 W/m², Ambient temperature 20°C, air mass of AM1.5 and wind speed of 1 m/s)

The specifications and characteristics contained in this datasheet may deviate slightly from our actual products due to the product developments and uncertainty of measurement devices. The specifications included in the datasheet are subject to change without prior notice.